

AutoValve proportional control valve provides unparalleled accuracy in the control of critical process flows. This valve is ideal for a variety of applications such as chemical blending and dispensing or DI water quick rinse metering.



AutoValve

Accurate and Reliable Performance

- Patented metering valve design provides excellent resolution and repeatability.
- The linear flow characteristics make this product ideal for blending and metering.
- Designed for remote 4 to 20 mA control input, these valves offer the ability to accurately control blending of chemistries at precise levels.
- Dual PTFE primary and secondary rolling diaphragms, along with an integral leak port, offer maximum protection.
- An optional display is available for monitoring valve performance, modifying programming and viewing diagnostic codes.

v a l v e s

Operation

Combining our patented slotted metering valve with a precision stepper motor, the AutoValve gives users the flexibility to create an infinite variety of process control possibilities. The stepper motor works with an analog input into the AutoValve and moves the metering valve to a position corresponding to the input. The AutoValve is designed to be used in a closed loop control system. Materials of construction make these valves excellent selections for ultra pure DI water, acids, solvents and other aggressive liquids. In addition to controlling the position of the valve, the AutoValve Control Board monitors a variety of valve operating parameters.

Pressure Drop ◆ 30 psi ■ 20 psi ▲ 10 psi ● 5 psi

The charts below represent 6A series valves;
for 6B series consult Futurstar.

Charts show:

- Flow characteristics for different Cv
- Flow versus % open
- DIW at 23°C (72°F)

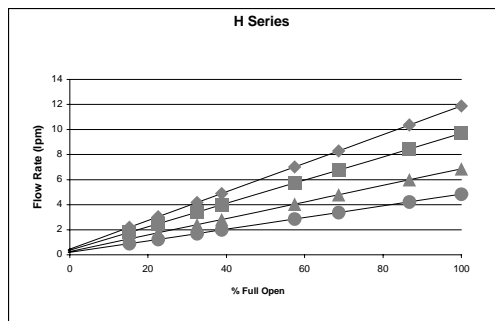
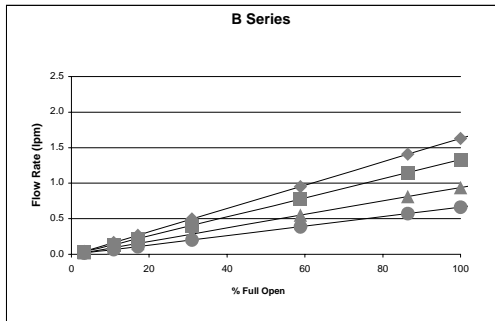
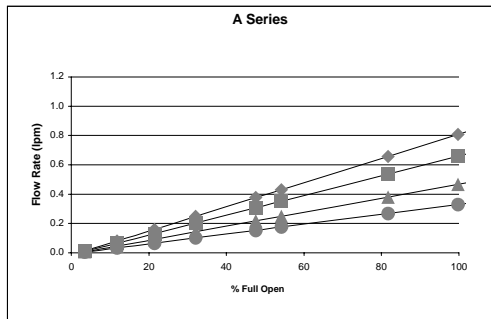

Specifications

MATERIALS

- Wetted parts:
PTFE, PFA
- Non wetted parts:
PVDF, polypropylene

OPERATING

- Reliability: > 3 mill cycles
- Maximum pressure: 60 psig
- Maximum fluid temp: 80°C (176°F).
- Electronic purge: required for ambient temperatures >30°C and/or process temperatures >40°C (Consult factory for flows and pressures)
- Consult factory for special applications

VACUUM: to 15" Hg (~380 torr or 7.5 psi) max.

- Reliability: 2 mill cycles
- Temperature: Process and ambient at 23°C

ELECTRICAL

Input power

- 24 Vdc (±1.5 Vdc)
- 0.2A Average (0.5A Peak, 1.5A Inrush)
- Overvoltage protected to 30 Vdc
- Reverse polarity protected to 100 Vdc

Input signal options*

- 4-20mA, Source or sink (249Ω load resistance)
- 1-5 Vdc (200Ω min. impedance)
- 1-10 Vdc (400Ω min. impedance)

*Overvoltage protected to 50 Vdc & polarity insensitive

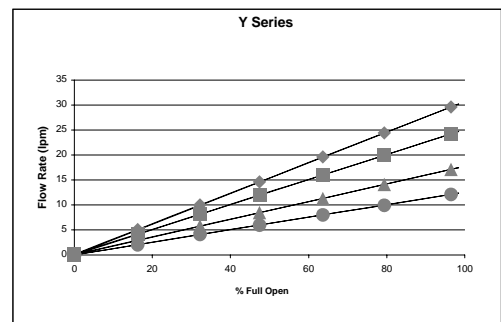
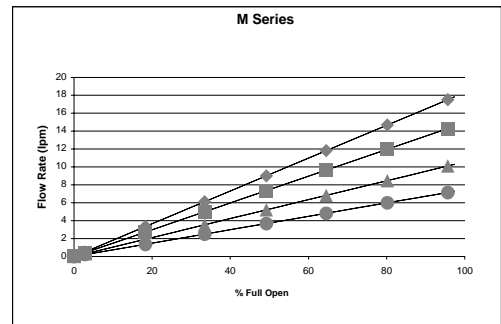

The above charts show typical performance of valves in DIW at 23°C. Valves are calibrated from zero to maximum Cv at 60 psig, but may vary up to 2% of full scale Cv over the life of the valve. Valve life, in full strokes, typically exceeds 3M cycles. Actual performance may vary based on application conditions.

Ordering Information

To order, select from options below.

Complete Part Number = 6●Cv Range●Cv Value-Connection Size●Connection Type-Control Signal●Cable Length

(Example: 6BU-8F-1A)

AutoValve	6		
Cv RANGE	A	B	
Cv VALUE *	A	0.02	
	B	0.13	
	H	0.55	
	I	0.61	
	M	0.82	2.40
	R		4.10
	S	1.13	
	U		6.10
	X		9.00
	Y	1.39	10.00
CONNECTION SIZE	1	1/8**	Max. Cv*** 0.08
	2	1/4	0.25
	3	3/8	1.00
	4	1/2	1.50
	6	3/4	6.10
	8	1	12.00
	CONNECTION TYPE	F	Flare
S		Pillar Super 300	
CONTROL SIGNAL	1	4-20 mA	
	2	0-5 VDC	
	3	0-10 VDC	
CABLE LENGTH	A	6' pigtail PVC shielded electrical cable	
	B	12' pigtail PVC shielded electrical cable	
	C	30' pigtail PVC shielded electrical cable	
	D	2' pigtail PVC shielded electrical cable	

*Consult factory for other Cv values.

**Available for Pillar Super 300 fitting style only.

***Maximum Cv recommended for connection size.

Installation Drawings

	Description	inches	mm
A	1/4" Flare	5.06	128.5
	3/8" Flare	5.20	132.1
	1/2" Flare	5.32	135.1
	3/4" Flare	5.66	143.8
	1" Flare	6.15	156.3
	1/8" Super 300	3.68	93.5
	1/4" Super 300	4.16	105.6
	3/8" Super 300	4.55	115.6
	1/2" Super 300	4.84	122.8
	3/4" Super 300	5.33	135.4
B	1" Super 300	5.84	148.3
	Cv .02-.82	6.5	165
	Cv .82-2.4	6.7	170
	Cv 2.6-6.1	6.7	170

Input power

- 24 Vdc (± 1.5 Vdc)
- 0.2A Average (0.5A Peak, 1.5A Inrush)
- Overvoltage protected to 30 Vdc
- Reverse polarity protected to 100 Vdc

Input signal options*

- 4-20mA, Source or sink (249 Ω load resistance)
- 1-5 Vdc (200K Ω min. impedance)
- 1-10 Vdc (400K Ω min. impedance)

*Overvoltage protected to 50 Vdc & polarity insensitive

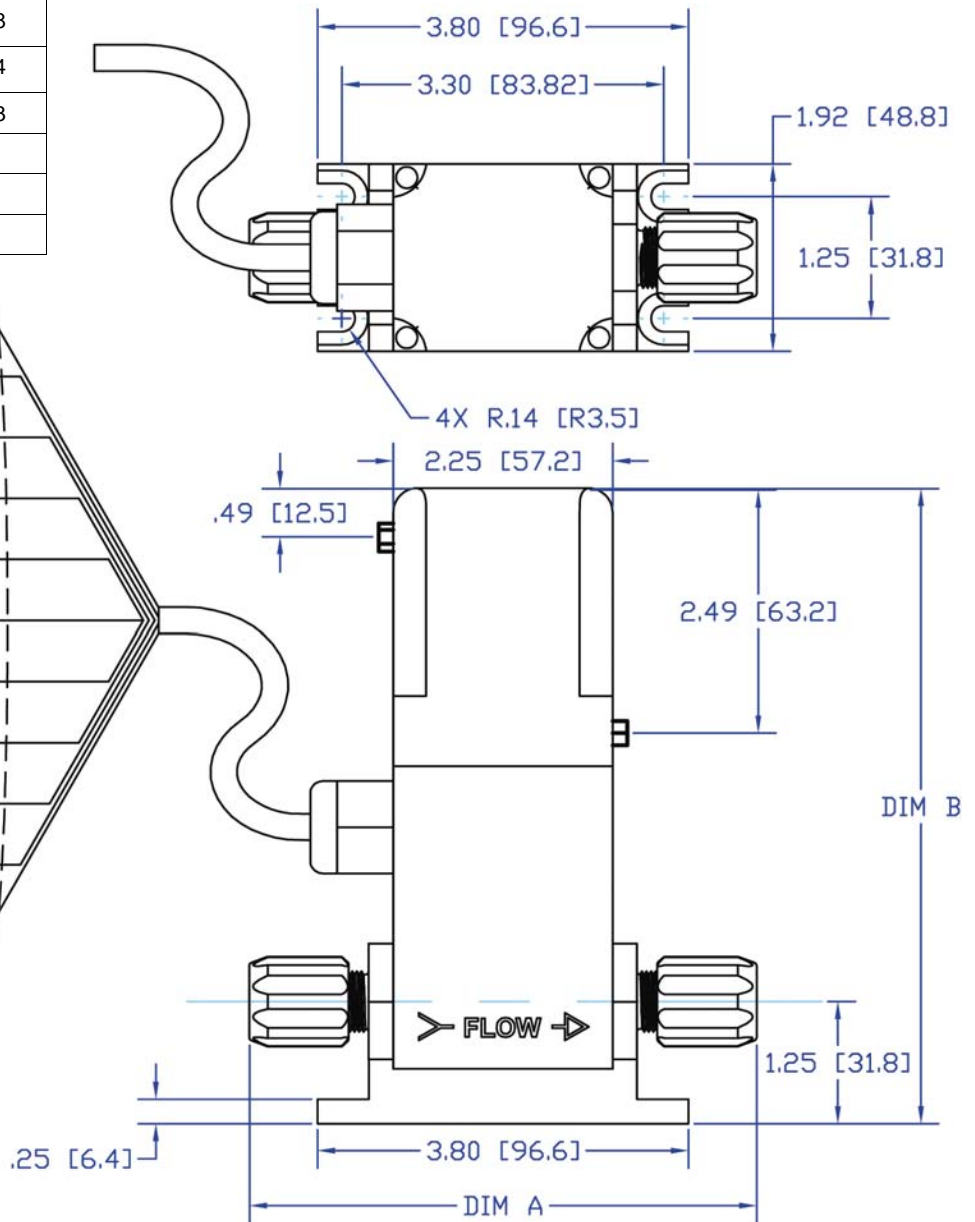
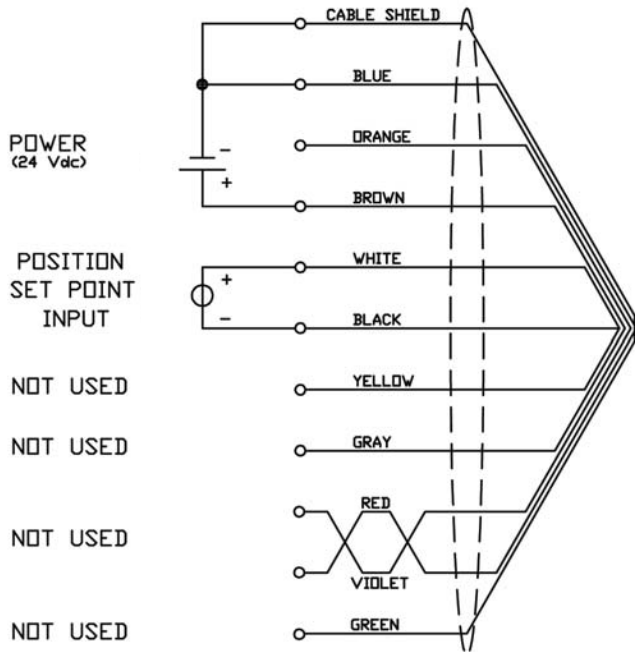

Futurestar Corporation • 6529 Cecilia Circle • Bloomington MN 55439

952 942 8388 • 952 942 8661 fax • www.futurestarcorp.com • U.S. Patents: 5565631, 5549277, 5381826, 5078004 • Others pending



Futurestar®, Pathfinder®, Odyssey® and Sentinel® are registered trademarks of Futurestar Corp. • Super 300 Type Pillar Fitting® is a trademark of NIPPON PILLAR PACKING CO., LTD.
©2006 Futurestar Corp., Printed in the USA, FS0011-1106, November 2006